

# PLUS

For More Info

Click Here --->



# Copyboard M-12S/M-12W/M-125

---

## User's Manual

Thank you for your purchase of the PLUS Copyboard.  
Please read this User's Manual carefully before use to take full advantage of the functions of this product. After you have finished reading the manual, please keep it for future reference.

The descriptions in this manual are for the M-12S, M-12W and M-125.

There are three types of copyboards: the 2-page standard size type (model M-12S), the 2-page wide size type (M-12W) and the 4-page + screen type (M-125).

In addition, depending on the product you have purchased, the printer and stand may be sold separately.

The descriptions and diagrams in this manual refer to the model M-12S.

\* When functions or operations are specific to a certain model of copyboard, the model name is specified.



## Trademarks

- Microsoft and Windows are registered trademarks or trademarks in the United States and other countries of the Microsoft Corporation.
- Adobe and Adobe Acrobat Reader are trademarks of Adobe Systems Incorporated.
- Velcro is a registered trademark of Velcro Industries.

The trademarks of the various companies and the product trademarks, even when not written down, will be given due respect.

Product names and company names appearing in this manual are registered trademarks or trademarks of the respective companies.

- (1) The contents of this manual may not be reprinted in part or whole without permission.
- (2) The contents of this manual are subject to change without notice.
- (3) Great care has been taken in the creation of this manual; however, should any questionable points, errors, or omissions be apparent, please contact us.
- (4) Notwithstanding Section (3), this company will not be responsible for any claims of loss or profit or other matters deemed to be the result of using this unit.
- (5) The use of a printer as the peripheral device of the PLUS Copyboard is taken to be a prerequisite; therefore, operation will not be guaranteed when the printer is used with a direct connection to a personal computer.
- (6) Manuals with incorrect collating or missing pages will be replaced.

# Table of Contents

<b>Important Safety Information</b> .....	<b>E-4</b>
<b>Package Contents</b> .....	<b>E-7</b>
<b>Main Functions</b> .....	<b>E-8</b>
<b>Names of the Parts</b> .....	<b>E-9</b>
Front .....	E-9
Rear .....	E-10
Changing the Height of the Unit.....	E-11
Control Panel (models M-12S and M-12W) .....	E-12
Control Panel (model M-125).....	E-13
<b>Operation Steps</b> .....	<b>E-14</b>
<b>Connecting the Power</b> .....	<b>E-15</b>
<b>Setting the Time</b> .....	<b>E-16</b>
<b>Printing</b> .....	<b>E-18</b>
Preparing the Printer.....	E-18
Basic Printing Operation .....	E-19
Selecting the printing density.....	E-21
Making additional copies .....	E-21
Cancellation of the print operation in progress .....	E-21
Specifying the Page (model M-125).....	E-22
Switching to the screen (model M-125) .....	E-22
Printing in the same ratio as the sheet surface (Model M-12W).....	E-23
Moving the sheet surface manually .....	E-23
<b>Using USB Memory</b> .....	<b>E-24</b>
USB Memory Storage Procedure .....	E-24
Saving Image Files on a Computer/Deleting Image Files .....	E-27
<b>Making the Function Settings</b> .....	<b>E-29</b>
Basic Setting Operations .....	E-29
Table of Function Numbers, Selected Modes and Lamp Statuses .....	E-30
<b>Accompanying Software</b> .....	<b>E-31</b>
Software Contents and Overview.....	E-31
Operating Environment.....	E-32
Dedicated software's setting items and factory defaults.....	E-32
<b>Meaning of Error Messages</b> .....	<b>E-33</b>
<b>Troubleshooting</b> .....	<b>E-34</b>
<b>Specifications</b> .....	<b>E-36</b>
<b>Appendix</b> .....	<b>E-37</b>
Connections and Wiring Diagram .....	E-37

For More Info



Click Here --->

## Meaning of the Terms Used in this Manual

- USB memory: refers to USB flash memory.
- USB memory storage: means the saving of sheet surface data using MEMORY (i.e., the USB port) of the operation panel. (The Copyboard has 3 USB ports.)
- Internal memory: indicates a temporary saving location of the image that has been read.
- “copy”: Both “print” and “USB memory saving” mean to “copy.”
- Page (model M-125): The number assigned to the sheet surface is called the “page”.
- Screen (model M-125): The “S” page for projecting images of optical devices is called the “screen”.
- “Sheet surface”: refer to the drawing portion.
- “Scroll” or “move”: indicates feeding of the sheet.

# Important Safety Information

## WARNING

The unit's rear panel should never be opened by anyone other than a qualified serviceperson. Contact your store of purchase to request internal inspection, adjustment, repair, and cleaning.

## CAUTION

Continued use of the unit under abnormal conditions (when the unit is emitting smoke, unusual odors or sounds) could lead to fire or electric shocks.

Turn off the unit's power immediately, then unplug the AC power adapter from the power outlet.

Check that no more smoke, etc., is being emitted, then contact a sales outlet for repairs.

Repairing the unit yourself is dangerous. Never attempt to do so.

## WARNING

This is a class A product. In a domestic environment this product may cause radio interference in which case the user may be required to take adequate measures.

## WARNING

The Federal Communications Commission does not allow any modifications or changes to the unit EXCEPT those specified by PLUS Vision Corp. in this manual. Failure to comply with this government regulation could void your right to operate this equipment.

This equipment has been tested and found to comply with the limits for a Class A digital device, pursuant to

Part 15 of the FCC Rules. These limits are designed to provide reasonable protection against harmful interference when the equipment is operated in a commercial environment. This equipment generates, uses, and can radiate radio frequency energy and, if not installed and used in accordance with the instruction manual, may cause harmful interference to radio communications. Operation of this equipment in a residential area is likely to cause harmful interference in which case the user will be required to correct the interference at his own expense.

You are cautioned that changes or modifications not expressly approved by the party responsible for compliance could void your authority to operate the equipment.

## DOC Compliance Notice

This Class A digital apparatus meets all requirements of the Canadian Interference-Causing Equipment Regulations.

## WARNING

This product is not for use in Computer Rooms. The description "Computer Rooms" refers to areas where an abundance of computer control equipment (such as high output servers) is being used.

It does NOT refer to environments such as offices or classrooms where there are simply PC's being used.



This symbol warns the user that uninsulated voltage within the unit may have sufficient magnitude to cause electric shock. Therefore, it is dangerous to make any kind of contact with any part inside of this unit.



This symbol alerts the user that important literature concerning the operation and maintenance of this unit has been included. Therefore, it should be read carefully in order to avoid any problems.



## SAFETY PRECAUTIONS

Heeding the safety precautions below will lengthen the product's service life and prevent fires, electric shocks and injury. Read these safety precautions carefully and be sure to heed them.

### Handling the AC power adapter

- Do not connect any AC adapter other than the dedicated one to the unit. Doing so could result in fire or other accidents.
- Do not use with voltages other than the voltage indicated. Doing so could result in fire or electric shock.
- Do not let the AC power adapter get wet. Doing so could result in fire or electric shock.
- Do not subject the AC power adapter to shocks. Doing so could result in fire or electric shock.

For More Info

Click Here --->



## Important Safety Information

### Handling the AC power adapter's cord and plug

- Damaging the power cord could lead to fire or electric shock.
    - When installing, do not squeeze the power cord between the product and a wall, rack, etc.
    - Do not modify or damage the power cord.
    - Do not place heavy objects on the power cord or pull strongly on it.
    - Do not place the power cord near heating appliances or otherwise heat it.
    - When unplugging the power cord, always do so by pulling on the plug, not the cord.
- If the power cord should be damaged, ask your store of purchase to replace it.
- If there is dust or metal objects on or near the power plug's blades, unplug the power cord then wipe the blade area clean using a dry cloth. Continued use without cleaning the plug could lead to fire or electric shock.
  - Do not plug in or unplug the power cord with wet hands. Doing so could lead to electric shock.
  - When moving the unit, turn off the power and be sure to unplug the power cord from the AC outlet first. Moving the unit with the power cord plugged in could damage the cord, leading to fire or electric shock.
  - Connect the power plug securely to the AC outlet, pressing the blades in to the hilt. Incomplete plugging could cause heating or attract dust, leading to fire. In addition, touching the plug's blades could cause electric shock.

### Handling the included AC adapter box

- An AC adapter box is provided with the copyboard for storing the AC power adapters of the copyboard and printer.

The AC power adapters and the power cords generate heat. Place them sufficiently apart and do not bundle the cables together, or the adapters and cables could heat up, leading to fire.
- Do not place vases, potted plants, glasses, cosmetics or containers of chemicals or water on the printer table. The liquid could spill and get into the AC adapter box, leading to fire or electric shock.

### Reflected Light from the Sheet Surface

The sheet surface of the main unit has a white glaze and when a projector or other optical equipment is projected, the reflected light could result in eye fatigue or other symptoms, so please be careful.

For model M-125, an image can be projected on the copyboard when you switch to the screen panel.

Also note that the light emitted from laser pointers can be linked to unexpected accidents, so please refrain from using them.

### Do not use the included CD-ROM in a player designed for audio CDs.

- Never use the included CD-ROM in a player designed for audio CDs. Doing so could produce loud noises that could impair your hearing. These noises can also damage your speakers.

### Installation

- Only a specially trained technician should install the set. Improper installation could lead to injury.
- When mounting on a wall, be sure to check first that the wall surface is strong enough to support the total weight

of the main unit, mount fittings and printer for a long period of time (including during earthquakes). If the wall is not strong enough, reinforce it before mounting the unit.

- Getting water on or inside the unit etc., could lead to fire or electric shock. Be particularly careful when using the unit near a window when it is raining or snowing and when using it near the shore of the ocean and lakes.
- Do not set the unit in hot places exposed to direct sunlight or in places exposed to an air conditioner or heating duct.

Do not set the unit in places exposed to soot or humidity (near humidifiers, etc.).
- When the power plug will be unplugged from the power outlet, please place the Copyboard near the power outlet so that it may be reached easily.

### Preventing Tipping (for stand type units)

To prevent tipping, heed the instructions below. Tipping could lead to personal injury or damage the unit.

- Use the unit on a flat floor.
- Be sure to attach the supplied stabilizers to the stand, and lock the stoppers of the casters. Failing to do so could result in the unit tipping and could lead to personal injury.
- Do not lean against the unit or apply excess force to the top of the unit.

### Cautions on Usage

- Take care that the unit does not get wet and that water does not get inside. Do not place objects containing chemicals, water or other liquids (vases, potted plants, glasses, cosmetics, etc.) on top of the unit. The liquid could spill and get inside the unit, leading to fire or electric shock.
- When lifting the unit to adjust the height, etc., the unit should be lifted by at least two persons to prevent it from tipping and causing personal injury.
- Do not move the sheet with paper or other objects attached to it. Doing so could cause damage.
- Do not wipe the unit or sheet with thinner, benzene, alcohol or other such products. Doing so could cause discoloration or damage the sheet.
- Only use markers designed exclusively for this product. Using other markers could damage the sheet. Also note that it may not be possible to erase the ink of other markers.
- When moving the (stand type) unit, remove the stabilizers and release the caster locks. Hold the sides of the main unit and move it gently. Avoid shocks.
- When not using for long periods of time, for safety be sure to unplug the AC power adapter from the power outlet.
- Make entries within the effective reading size. (See page E-9) Portions that are drawn outside of this range might not be printed or copied when saving to USB memory or personal computer.

For More Info

Click Here --->

E-5



## Important Safety Information

### Cleaning

- When the sheet has become soiled, wiping it with a moist cloth that has been wrung well, then before the sheet surface has dried wipe it dry with a soft, clean, dry cloth. After cleaning, allow the sheet to dry completely before use.  
Do not use heavily soiled erasers, wet tissue, office cleaners, neutral detergent, or other cleaners.
- Do not wipe the copyboard or sheet with thinner, benzene, alcohol, etc. Doing so could cause discoloration or damage the sheet.
- Wipe of any marks from markers on the pen tray or the frame cover using a damp, thoroughly wrung out cloth. For cleaning of the printer, please refer to the printer's operating instructions.
- When the erasing surface of an eraser has become soiled, exchange the sponge with a spare one, and then use. Using a soiled eraser will soil the sheet surface, and it will be difficult to remove the soiled matter from the sheet.

### Handling the CD-ROM

- Do not touch the surface which has no printing (the surface on which the data is recorded). If this surface is dirty the data will not be read properly.  
Also, do not stick paper, stickers, etc., on the CD-ROM.
- Do not leave for long periods of time in places exposed to direct sunlight or near heating appliances, and do not drop or bend the CD-ROM. The disc may get warped, making it impossible to read the data.

### USB Memory

- The USB memory formats supported by the copyboard are FAT, and FAT 32. There are also types of USB memory that cannot be used by this unit. Check the PLUS Vision web site for types of USB memory that have been verified to work with the copyboard.
- As a provision against the unlikely event of a problem with or disappearance of the data saved in the USB memory, we recommend that the data be regularly saved to other media.
- PLUS Vision will not be responsible for the loss of content stored in the internal memory of this unit (i.e., images that have been read), or in USB memory.

### USB Cables

When using a USB cable other than the one supplied with the Copyboard, use a USB shielded cable bearing the USB-IF logo certification. Do not use the Copyboard connected to a USB hub. Improper operation may result.

### Do not draw on the screen (model M-125)

The screen is designed exclusively for use with optical devices. If you draw on the screen, the ink cannot be erased with the included eraser. If you accidentally draw on the screen, wipe off the ink with a diluted solution of neutral detergent, then carefully wipe off any remaining detergent.

- Note that copying illegal material (tantamount to possession of illegal material) is subject to prosecution.
- This product includes parts considered as "strategic material" as per the Foreign Exchange and Foreign Trade Control Act of Japan. Authorization as per said Act is required to export this product from Japan.

For More Info

Click Here ---->



# Package Contents

Click Here --->

The package contents are as described below. Please check before use.

### Copyboard, main unit [1]

See "Assembly and Setup Manual" for information about the assembly parts of the copyboard.

### Printer\* [1]

Please see the instruction manual of the printer for information about the printer accessories.

### Stand\* [1]

\* The printer and stand may be sold separately.  
\* Depending on the product you have purchased, the printer and stand may be sold separately.

### Assembly and installation parts

#### • Wall mount brackets [1 set]

These fittings are used to mount the copyboard on a wall (See the Assembly and Setup Manual).  
(The set includes four copyboard brackets and 16 M4 mounting screws.)

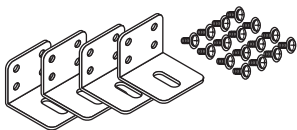

#### • AC adapter box (1 unit, with 2 masking screws)

Use this to store the AC power adapters of the copyboard and printer. (See the Assembly and Setup Manual.)

#### • Cable covers specifically for the copyboard (see the Assembly and Setup Manual)

Model M-12S/M-125: 1 cover  
Model M-12W: 2 covers

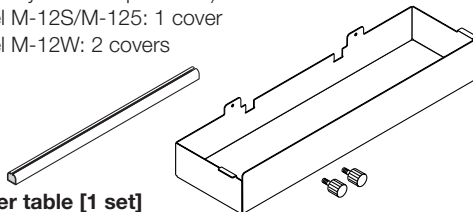

#### • Printer table [1 set]

The printer is placed on this printer table.  
(The set includes one printer table, brackets for left and right sides, 10 M3 assembly screws, 4 M4 screws, 2 printer guides, 2 cushions and Velcro 2 sets )

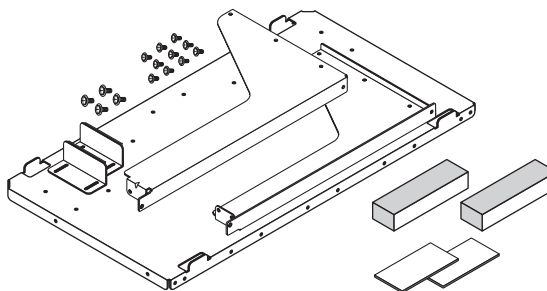

### Copyboard Accessories

#### • Dedicated markers

(One each of black, red, blue, and green)  
Use these markers to draw on the sheet surface.

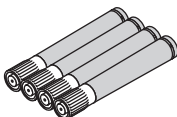

#### • Dedicated eraser (with 2 spare sponges) [1]

Use this to erase the drawing.

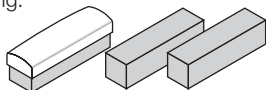

#### • AC power adapter (with power cord) [1]

This is the power adapter for supplying power to the copyboard (See Page E-37).  
(HEC-AP065-24V)

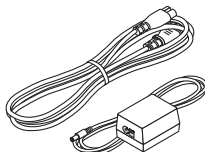

#### • USB cable (type B ↔ type A) [1]

[PLUS code 715255400]  
This cable is for connecting the copyboard's Printer connector with the exclusive printer (page E-37).  
(If not using a printer, it can be used to connect a computer. For connection instructions, see the separate "Software Operation Manual".)

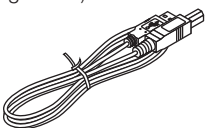

### Documents

#### • User's manual [1] (this manual)

Includes information about safety precautions and the use of the copyboard.

#### • Software Operation Manual ... 1

This manual includes instructions on setting the copyboard's operating environment and transferring images to the computer.

#### • CD-ROM [1]

This includes the user's manual (in PDF format) and special software for using the copyboard (PLUS TOOLBOX).

#### • Quick Guide [1 set]

The Quick Guide can be hung from a hook in a convenient location close to the copyboard.

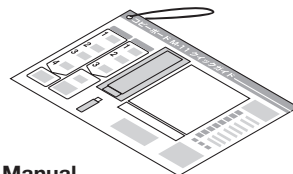

#### • Assembly and Setup Manual

Information covers the setup of the copyboard and the connections with the printer.

# Main Functions



## **Text or images drawn on the copyboard's sheet surface can be printed in color or black and white on regular paper.**

A press of the "Print" button on the operation panel quickly prints what has been hand written on the sheet surface to regular LETTER or A4 size paper.

By mitigating the need to take notes, the participants of the meeting can concentrate on the agenda.

The paper printout can be written on and a stamp can also be affixed which is convenient if it is to be kept as a record of the meeting, or circulated. The printer can continuously print a maximum of 20 sheets.



## **Text or images drawn on the copyboard's sheet surface can be stored in a USB memory device as image files.**

When a USB memory device is inserted into the bottom of the control panel and the "Save" button is pressed, the material drawn by hand on the sheet surface is stored as an image file in the USB memory device.



## **Text or images drawn on the copyboard's sheet surface can be loaded directly onto a computer as image files.**

When a USB memory device is inserted into the bottom of the control panel and the "Save" button on the control panel is pressed, the data drawn by hand on the sheet surface is stored on the USB memory device as an image file (in either PNG, JPEG or PDF format, selectable).



## **4 copyboard pages + 1 screen (model M-125)**

In addition to the 4-page copyboard function, this model includes a screen designed for projecting images with a regular or overhead projector. This screen can be selected at the touch of a button. A single machine serves as both the copyboard and projector screen, saving space and preparation time.

\* You cannot draw on the screen with markers. Also note that you cannot print images projected on the screen surface or save them on a USB memory device or computer.



## **Maintenance-free, Low Power Consumption**

RGB, 3-primary-color LEDs are used as the reading light source which means that there is no need to replace a fluorescent tube as with previous copyboard models. In addition, unlike fluorescent tubes, LEDs need only be lit when reading the sheet surface which is reflected in low power consumption.



## **Erase Reminder function**

When turning off the power, if there is a page (sheet surface) you have forgotten to erase, the sheet automatically moves to the surface that is not yet erased and the power turns off.



## **Header/footer function**

The included software can be used to insert text (titles, the company name, the date, etc.) or images in the margins at the top and bottom of the page and print or store the same data each time.

For More Info

Click Here --->





**Front**

Click Here --->

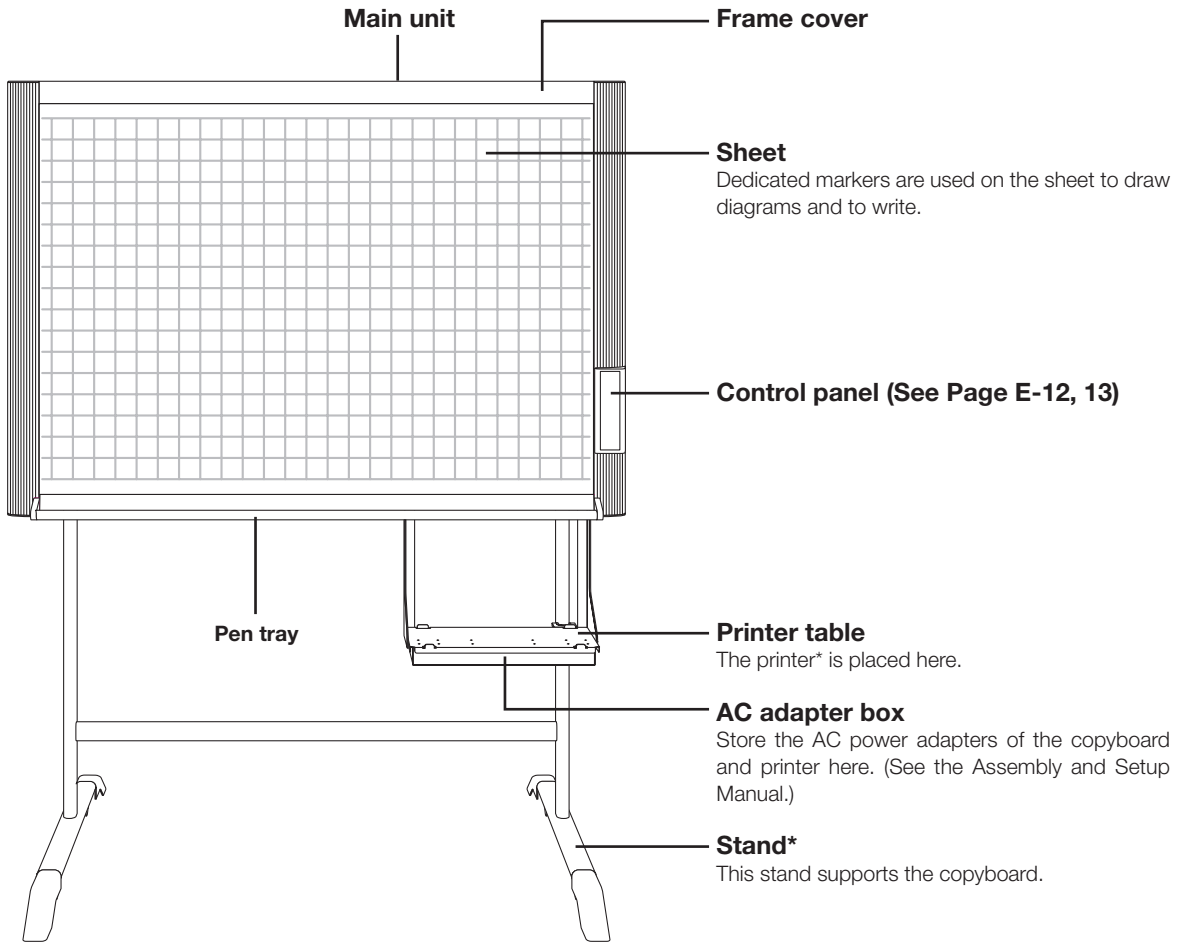

\* This illustration does not show the printer or connection cords.

\* Depending on the product you have purchased, the printer and stand may be sold separately.

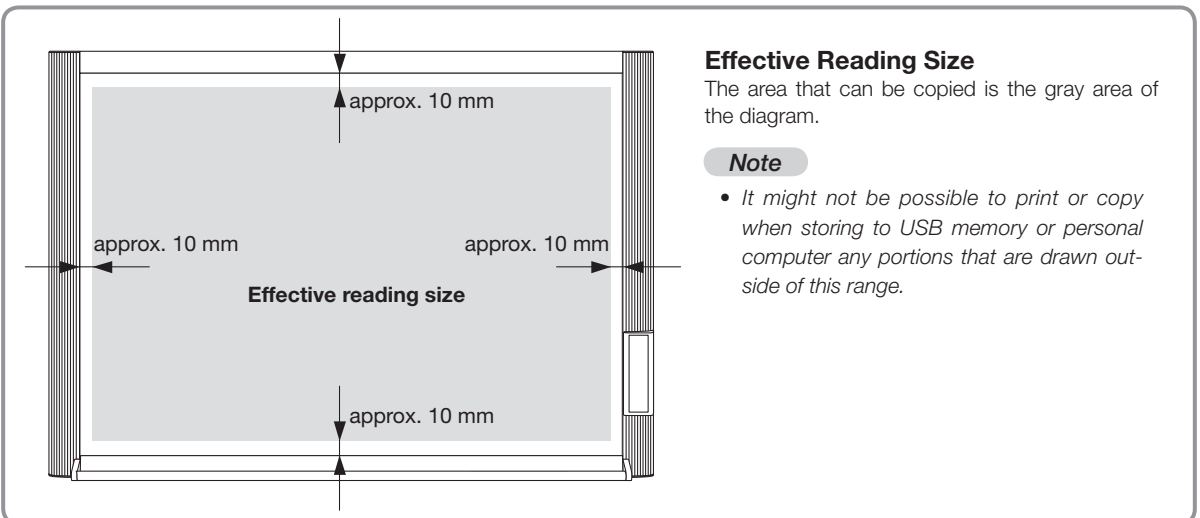

## Names of the Parts

### Rear

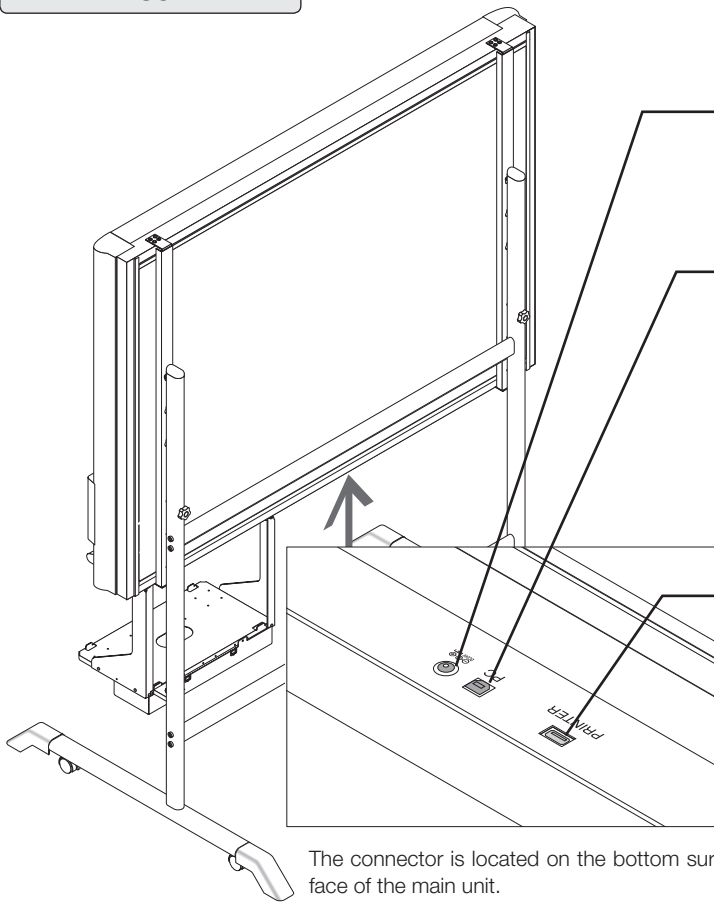

#### DC input connector

Connect this with the DC plug end of the AC power adapter. (See Page E-37.) (Only connect the supplied AC power adapter; nothing else.)

#### Personal computer (PC) dedicated USB port (Type B)

Connect this with the USB port (type A) of the PC. (See Page E-37.)  
Special software can be used to transfer image data directly to the computer and set the copyboard's operating environment. To use these functions, first install the drivers and software on the included CD-ROM onto the computer. (See the separate software operation manual.)

#### Printer connector (USB port Type A)

Connect this with the USB connector of the printer (See Page E-37).  
(The printer connector is dedicated for use with a printer; use it only with a printer.)

The connector is located on the bottom surface of the main unit.  
The diagram view is seen from the bottom.

\* This illustration does not show the printer or connection cords.

For More Info

Click Here --->



#### Locking and unlocking the casters of the stand\*

Lock the casters with the stopper after setup. To move the unit, remove the stabilizers and release the caster stopper. Press the bottom of the stopper to lock it. Press the top to release it.

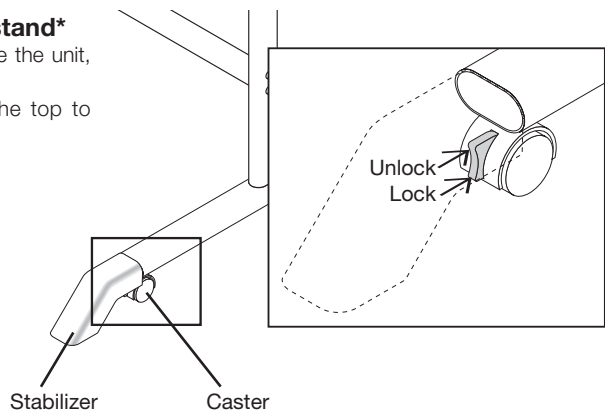

## Changing the Height of the Unit

This is the height adjustment when setting up the copyboard on the optional stand. The stand height can be adjusted to 3 levels by 100 mm.

### CAUTION

- Please have 2 or more persons lift the Copyboard when installing it or making a height adjustment. If the unit is dropped or falls over, this could cause unforeseen injury.
- When a printer is mounted on the copyboard, remove the printer before performing this procedure. Failure to do so could result in injury due to unexpected falling or tipping.
- Unplug the power plug from the wall power outlet and remove the power cord from the stand's cable cover before performing this procedure. Failure to do so could result in injury due to the stand tipping over unexpectedly.

Please lock the casters by pressing the lower portion of the lock buttons of them.

**(1) Unplug the AC power adapter's power plug from the wall power outlet and remove the power cord from the stand's cable cover.**

**(2) Remove the printer from the printer table.**

Disconnect the USB plug from the printer and the DC power plug, loosen the printer guide's fixing screws and remove the printer.

**(3) Remove the two locking screws (located at the left and right sides).**

**(4) Change the hole position of the Copyboard rear frame.**

The Copyboard will disengage from the hooks when it is lifted up about 1 cm.

Fully hook the (2 left and right) installation holes of the main unit rear frame onto the hooks of the stand.

If a stay (for preventing shaking) is mounted on the printer table, insert the stay in its original position.

(See (7) on page 5 for mounting instructions.)

**(5) Attach the locking screws to the 2 locations (left and right) and tighten to the rear frames.**

**(6) Return to original by following the steps in reverse.**

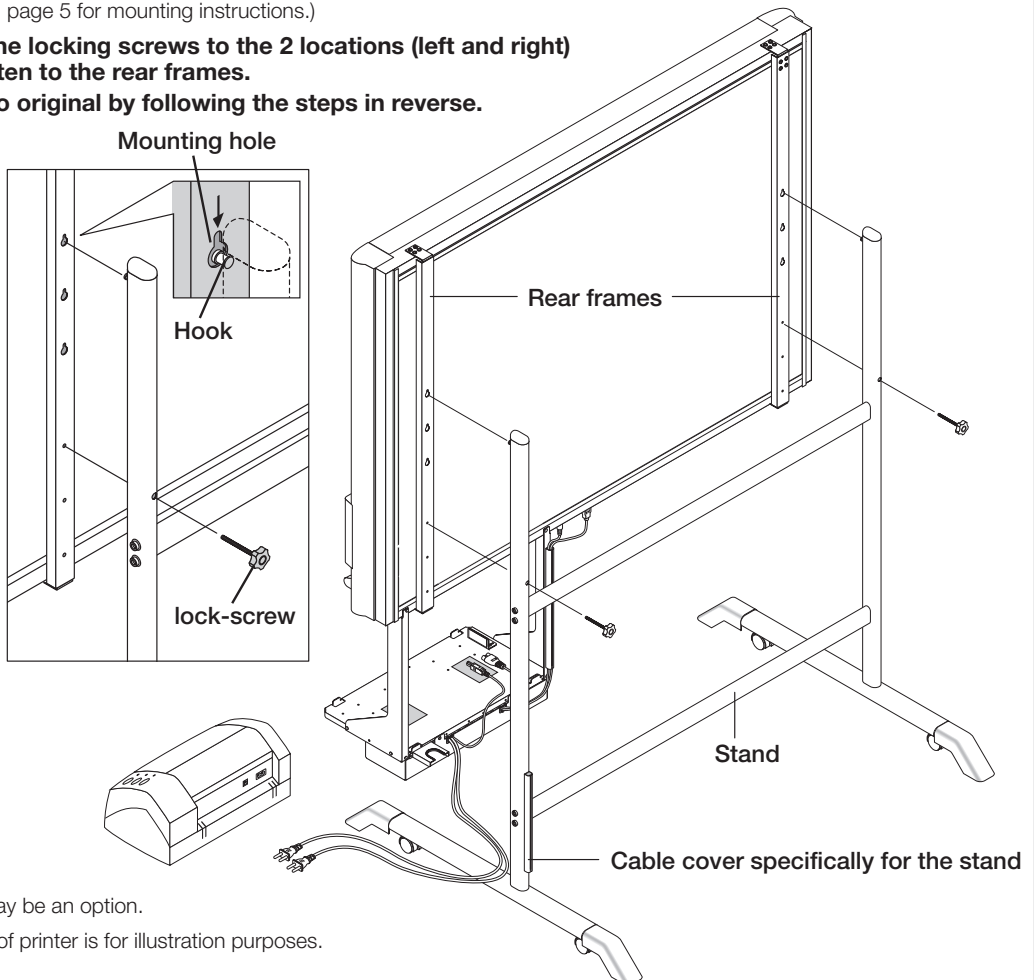

\*The printer may be an option.

\* Appearance of printer is for illustration purposes.

# Names of the Parts

## Control Panel (models M-12S and M-12W)

When pressing a button, please press the center area (i.e., the round and protruding portion). The button may not work if it is pressed on a corner.

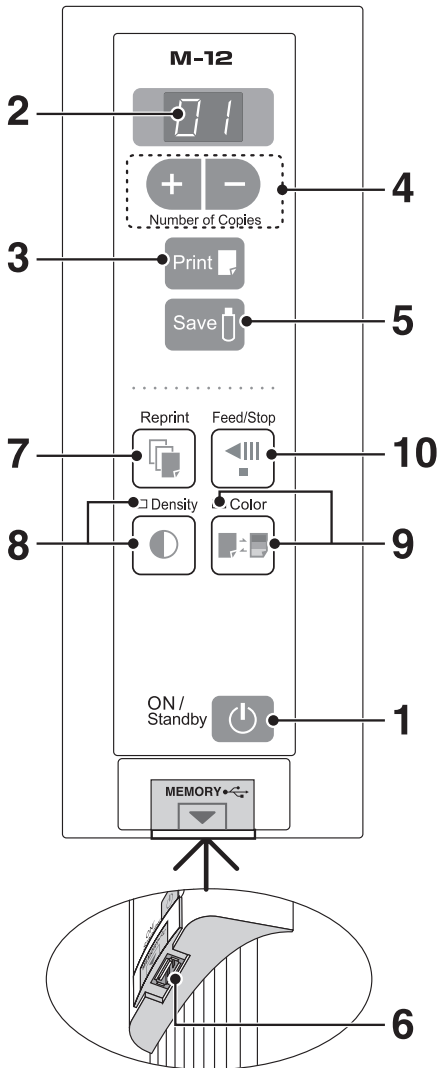

### 1 ON/Standby button

Turns the copyboard's power on and off (standby mode). The function settings can be made by pressing the Density and ON/Standby buttons simultaneously. For details, see page E-29.

#### Note

If the Erase Reminder function has been set, the sheet moves to the surface that has not yet been erased before the power turns off \*1.

\*1 Depending on the usage method, the Erase Reminder function may not operate properly.

### 2 Display window

This 7-segment LED displays the number of copies to be printed, the USB memory storage operating condition, and error information. Please see Page E-33 for details about error information.

### 3 Print button

Moves a one-screen portion of sheet and reads it, then prints the number of copies displayed in the display window.

### 4 + / - buttons (Number of copies)

Pressing the + button or the - button sets the number of copies to be printed (to a maximum of 20 sheets). The number of copies appears in the display window.

### 5 Save button (USB memory storage)

Moves a one-screen portion of sheet and reads it, then stores the data on a USB memory.

### 6 Memory port (USB port Type A)

Saves in commercially-available USB memory images that have been read by the copyboard.

### 7 Reprint button

Prints the previously printed sheet surface one more time. (The sheet does not move.) The number of copies can be changed, but the density and the color/monochrome selection cannot be changed.

### 8 Density button

Selects the copying density, either "standard" or "dark". This function will be effective at time of printing, USB memory storage, and personal computer storage.

#### Density mode lamp

The density mode indicator lights green when "dark" is selected.

### 9 Color button

Selects whether to print (or store in memory) in "color" or "black & white".

#### Color mode lamp

The color mode indicator lights green when "color" is selected.

\*When a black & white printer is connected, the printout will be in black & white even when "Color" is selected.

### 10 Feed/Stop button

Scrolls the sheet one screen portion left, then stops automatically. A press of this button while scrolling will stop the scrolling.

For More Info

Click Here --->



# Names of the Parts

Click Here --->

## Control Panel (model M-125)

When pressing a button, please press the center area (i.e., the round and protruding portion). The button may not work if it is pressed on a corner.

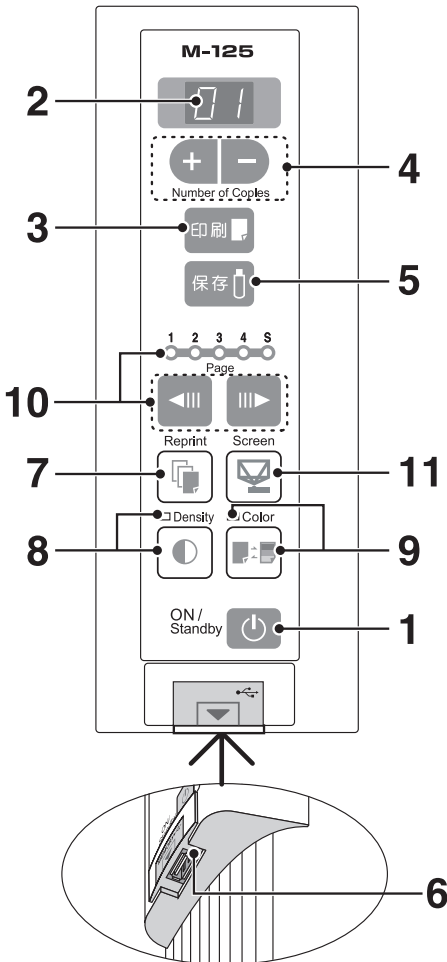

### 1 ON/Standby button

Turns the copyboard's power on and off (standby mode). The function settings can be made by pressing the Density and ON/Standby buttons simultaneously. For details, see page E-29.

#### Note

If the Erase Reminder function has been set, the sheet moves to the surface that has not yet been erased before the power turns off. \*1.

\*1 Depending on the usage method, the Erase Reminder function may not operate properly.

### 2 Display window

This 7-segment LED displays the number of copies to be printed, the USB memory storage operating condition, and error information. Please see Page E-33 for details about error information.

### 3 Print button

Moves a one-screen portion of sheet and reads it, then prints the number of copies displayed in the display window.

### 4 + / - buttons (Number of copies)

Pressing the + button or the - button sets the number of copies to be printed (to a maximum of 20 sheets). The number of copies appears in the display window.

### 5 Save button (USB memory storage)

Moves a one-screen portion of sheet and reads it, then stores the data on a USB memory.

### 6 Memory port (USB port Type A)

Saves in commercially-available USB memory images that have been read by the copyboard.

### 7 Reprint button

Prints the previously printed sheet surface one more time. (The sheet does not move.)

The number of copies can be changed, but the density and the color/monochrome selection cannot be changed.

### 8 Density button

Selects the copying density, either "standard" or "dark". This function will be effective at time of printing, USB memory storage, and personal computer storage.

#### Density mode lamp

The density mode indicator lights green when "dark" is selected.

### 9 Color button

Selects whether to print (or store in memory) in "color" or "black & white".

#### Color mode lamp

The indicator lights green when "color" is selected.

\*When a black & white printer is connected, the printout will be in black & white even when "Color" is selected.

### 10 Page change buttons

Use these to switch pages.

- Each press of the right page change button moves the page indicator one step in the sequence of 1 → 2 → 3 → 4 making it flash, and scrolls the copyboard to the specified page.

- Each press of the left page change button moves the page indicator one step in the sequence of S → 4 → 3 → 2 → 1 making it flash, and scrolls the copyboard to the specified page.

#### Note

• Scrolling to the screen (S page) is not possible with the right page change button.

#### Page indicators

The indicator for the currently displayed page lights (green).



When scrolling, the indicator for the specified page flashes while the page is scrolling, then stops flashing, remaining lit, once scrolling stops.

### 11 Screen button

When pressed, the sheet scrolls to the screen (the S page).

# Operation Steps

Click Here --->

The copyboard uses a CCD image sensor to read the diagrams and text that have been written down with special (4-color) markers, and accumulates the image data in internal memory. Pressing the Print  button prints out the sheet surface image data from the printer, and pressing the Save  button stores the image data to USB memory.

## Preparation

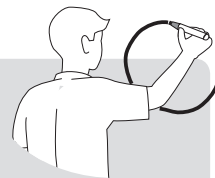

- **Set up the newly purchased copyboard and connect a printer.**  
See a separate manual titled "Assembly and Setup Manual."
- **Plug the AC power plugs of the copyboard and printer into wall power outlets. See page E-15.**
- **Set the time of the newly purchased copyboard. See Page E-17.**



## Draw on the Sheet Surface



Please draw with the dedicated markers that have been supplied. To erase, use the supplied dedicated eraser. Please be sure to draw with the dedicated markers. Failure to do so may result in a drawing that cannot be erased or soiling of the sheet. To move the sheet manually (models M-12S and M-12W only), see "Moving the Sheet Surface Manually" on page E-23.

## Printing

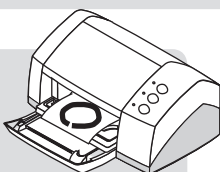
- (1) Set A4 or letter size paper.  
Do not set anything other than A4 or letter size paper.
- (2) Press the ON/Standby  button of the copyboard and switch on the power.
- (3) Switch on the printer power.  
For instructions on operating the printer, see the printer's operating instructions.
- (4) Press the Print  button. The copyboard will move a one-screen portion of sheet, read the image, and start the copy operation\*.  
See "Printing" on Page E-18.





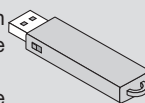

## Saving to USB Memory

- (1) Press the ON/Standby  button of the copyboard to switch on the power.
- (2) Insert USB memory into the Memory  port (USB port) of the copyboard.
- (3) Press the Save  button.  
See "Using USB Memory" on Page E-24.





## When Not Using the Copyboard

- (1) By all means, cleanly erase the drawing from the sheet surface with the dedicated eraser. (Leaving the drawing for a long period will make it harder to erase.)
- (2) Press the ON/Standby  button of the copyboard and switch off the power (standby mode).  
The power cannot be switched off while the USB memory remains installed. (This is a prevention function against forgetting to unplug the USB memory.)  
The copyboard is equipped with an Erase Reminder function for the back side of the sheet. By factory default this function is disabled. It can be turned on by either by changing the function settings (see page E-29) or by setting "Enable" at "Erase Reminder" in TOOLBOX. (For instructions on operating TOOLBOX, see the separate "Software Operation Manual".)
- (3) Switch off the printer power.

- Press the Print  button to perform the read operation. Pressing the Save  button during printing will store the information in the USB memory after printing is completed. Press the Save  button to perform the read operation. Pressing the Print  button while storing the information in the USB memory will start the printing operation after storage is completed. This allows both printing and USB memory storage to be performed in a single reading operation.

### Note

- Press the ON/Standby  button more than 5 seconds after connecting the AC power adapter to the copyboard unit or after turning off the power.
- The color of the images when printed in color or when saved in USB memory will differ somewhat from the marker colors.
- Blurred characters, thin lines, overlapping of markers and other factors can cause colors to differ in places and can also result in portions that cannot be scanned successfully. When "Density" is set to "Dark", the overall print may be dark and the ruled line may appear on the copy.  
In the case of the combination of Dark and Color Mode, the black ink may be mixed into other color.
- The built-in memory accumulates the read data that was previously printed or stored in USB memory. This data is erased when the power is switched off with the ON/Standby  button.

# Connecting the Power

## Note

### About the connection and the AC adapter box

The AC power adapters of the copyboard and printer are stored in the AC adapter box.

In this manual, "AC power plug" refers to the AC power plug of either the copyboard or the printer.

If the AC power adapter is not connected or placed in the AC adapter box, see the separate " Assembly and Setup Manual " and connect according to the purpose

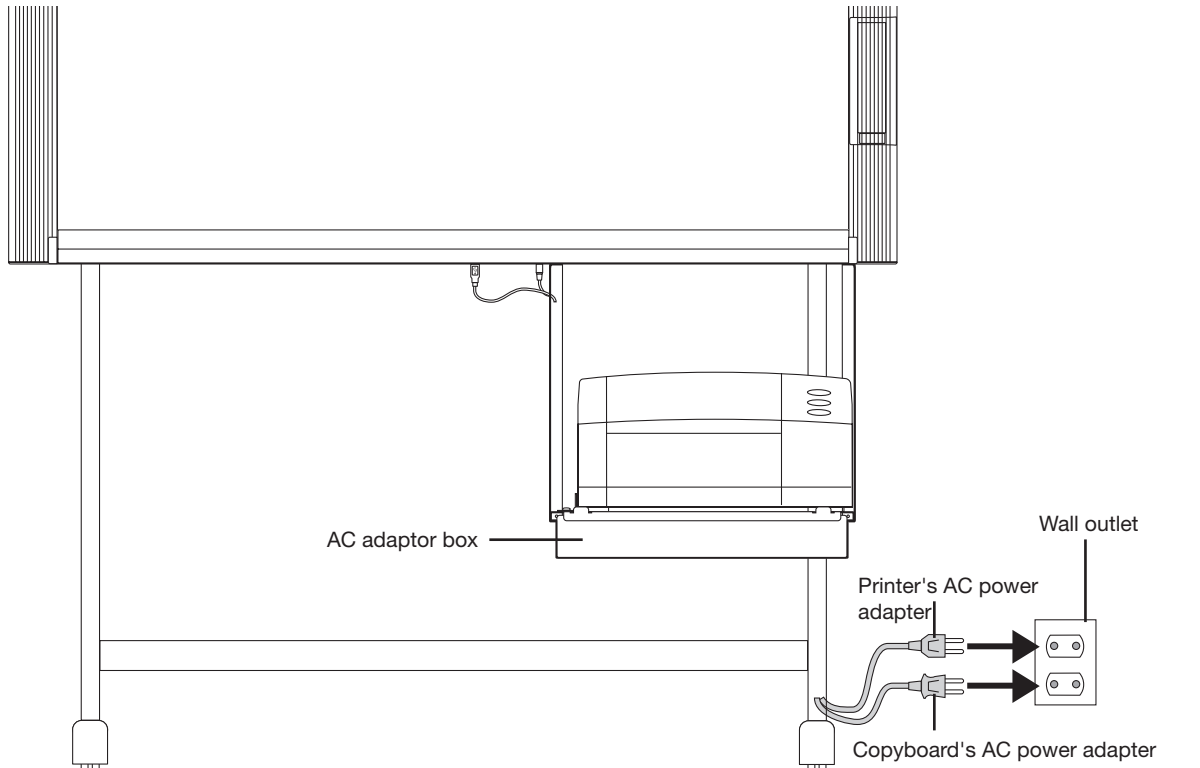

\* Be sure to insert all the plugs securely.

### To use the copyboard, connect the copyboard's AC power plug to a wall power outlet.

The main power turns on. In this manual, this is referred to as the "standby mode".

The descriptions in this manual assume that the AC power plug is connected (that the unit is in the standby mode).

### To use the printer, also connect the printer's AC power plug to a wall power outlet.

Before printing, turn on the printer's power.

### When not using the copyboard for long periods of time

Disconnect the AC power adapter's power plug from the AC power outlet in the wall.

## Notice

- When the AC power adapter's power plug is unplugged from the power outlet, place the copyboard near the power outlet so that it can be reached easily.
- The supplied AC power adapter and AC power cord are intended for exclusive use with this product. Never use them with another product.

For More Info

E-15 [Click Here --->](#)

# Setting the Time

Click Here --->

Set the copyboard's clock properly. The date and time are printed in the header/footer when printing and recorded in the file data when saving the file.

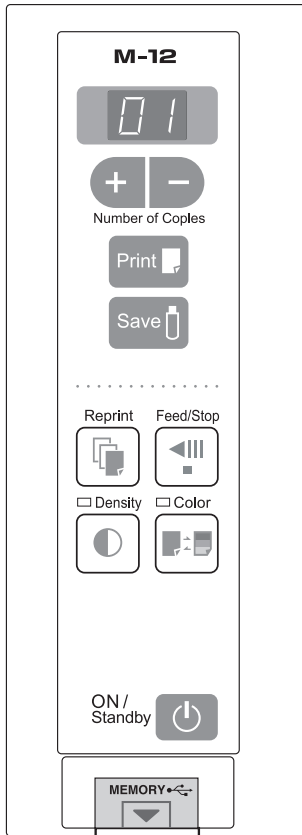

## Overview of the Operation

### 1 Switch to the function settings.

With the power turned on, press and hold in the Density button, then press the ON/Standby button.



### 2 Press the Print button to switch to the time setting.

### 3 Display the day and hour setting mode

Setting mode information indicated in the display window



(First 2 digits) (Last 2 digits)  
Year Month Day Hour Minute

### 4 Set the date and time of the setting mode

One press of the + or the - button will enable the settings to be made. Press the + or - button and make the adjustment.

### 5 Press the Print button to confirm

There is a change to the next setting mode. Repeat steps 4 and 5 to set the current time.

- Pressing the ON/Standby button during operations 3 to 5 will cancel the incomplete settings and return to the time prior to starting the settings.

### 6 Completion

When the Print button is pressed after setting the minutes setting mode ("c.6" is displayed), the display returns to "F1" (function settings), then after 10 seconds automatically returns to the normal mode ("01" is displayed).

**Preparation:** Connect the copyboard's AC power plug to a wall power outlet. E-15

**Example:** Set the time to 2:16 pm, November 8, 2008 (2008.11.08 14:16).

## 1 Press the ON/Standby button to switch on the power.

The LED of the display window will light and the power will be switched on.



## 2 Press the ON/Standby button while holding down the Density button to switch to "Function Settings"

The LEDs on the display window display "F1". If no button is operated for 10 seconds, the set returns to the normal mode.



## 3 Press the Print button while "F1" is displayed to finalize.

The mode switches to the time setting mode (c.1). If no button is operated for 10 seconds while in the time setting mode, the mode switches to the function settings mode.

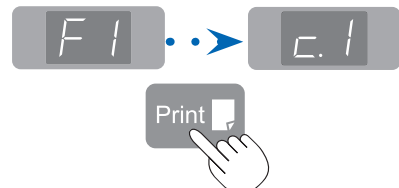

# Setting the Time

**4** Press the + button or the - button, select 20 (the first 2 digits of the year), and press the Print button to finalize.

There will be a change to the "last 2 digits of the year" setting mode (c2 display).

**Note**

- The factory default setting is 20. Pressing the Print button in this condition will result in a change to the "last 2 digits of the year" setting mode.

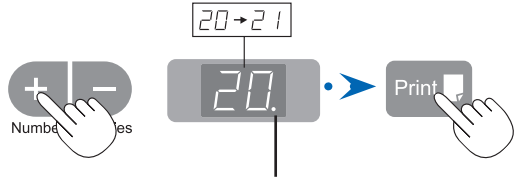

The dot will flash while making settings.

**5** Press the + button or the - button, select 08 (the last 2 digits of the year), and press the Print button to finalize.

There will be a change to the "month" setting mode (c3 display).

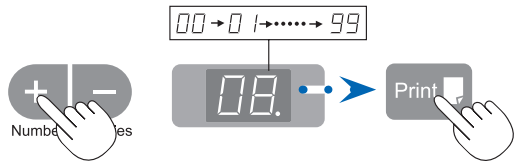

**6** Press the + button or the - button, select 11 (the month), and press the Print button to finalize.

There will be a change to the "day" setting mode (c4 display).

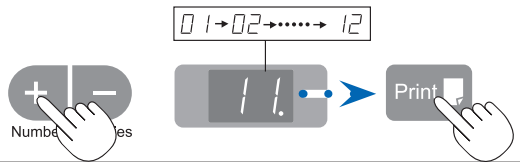

**7** Press the + button or the - button, select 08 (the day), and press the Print button to finalize.

There will be a change to the "hour" setting mode (c5 display).

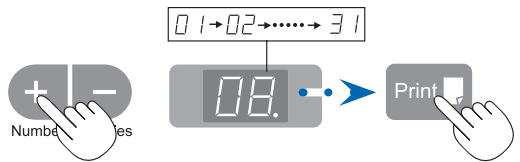

**8** Press the + button or the - button, select 14 (the hour of the 24-hour display), and press the Print button to finalize.

There will be a change to the "minute" setting mode (c6 display).

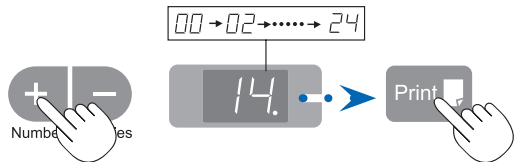

**9** Press the + button or the - button, select 16 (the minutes), and press the Print button to finalize.

The display returns to "F1" (function settings mode).

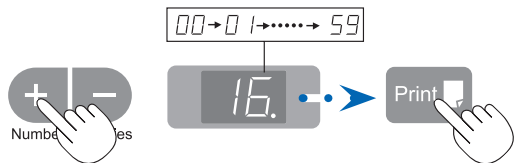

The display returns to the normal mode (the number of copies ("01") is displayed) if you wait 10 seconds or press the ON/Standby button.



**This completes the time setting.**

For More Info

Click Here --->



# Printing

Use a printer to print out the image that has been drawn on the sheet surface. Operations and names of parts differ from printer to printer. For details of operations, see your printer's operating instructions.

## Preparing the Printer

Please check that the copyboard and the printer have been connected. See Page E-37.

1

### Set the paper.

- Please use A4 or letter size printer paper. See your printer instruction manual for details.
- 1) Arrange the paper edges so that they are even.
  - 2) Insert paper at the specified position of the paper tray.
  - 3) Press the paper guide gently until it touches the paper.

#### Note

See your printer's operating instructions for a description of the paper that can be used.

2

### Switch on the power.

Press the power switch. The power indicator lights.

### This completes the preparation of the printer.

Press the Print  button on the copyboard's control panel. One page worth of data is read and the printing operation starts.

#### Note

- Depending on the printer, indicators, etc., may flash after the power is turned until the printer is prepared to print. In this case, see the printer's operating instructions and check that the printer is ready before starting the printing operation on the copyboard.

3

### When finished printing...

Switch off the printer power and remove the paper. Close the paper tray.

#### Notice

- Caution: Do not turn off the power or disconnect the USB cable during printing.

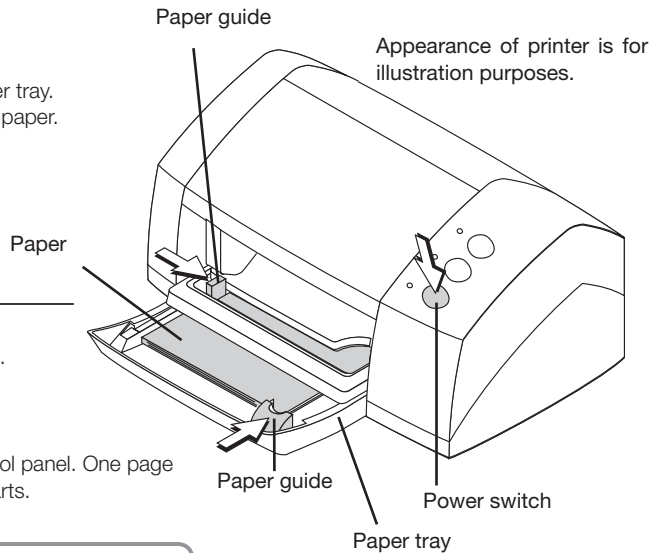

For More Info

Click Here --->



This function prints the sheet screen of the copyboard on the printer connected to the copyboard.

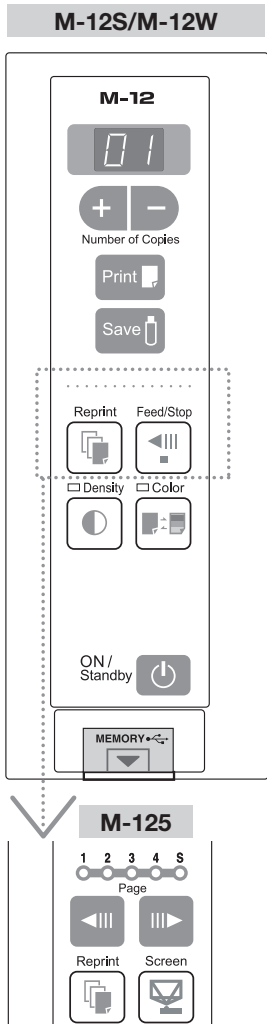

**Note**

- Text (titles, the company name, the date, etc.) or images can be inserted in the margins at the top and bottom of the pages and the same information printed on all pages. The information at the top of the page is called the header, the information at the bottom the footer. For instructions on creating headers and footers, see the separate "Software Operation Manual".

**Basic Printing Operation**

**Preparation:**

Preparation: Check that the AC power plugs of the copyboard and printer are connected to wall power outlets. See Page E-15.



**Press the ON/Standby button and switch on the power.**



**Prepare the printer. (See the previous page.)**

**Note**

- When turning on the power, wait about 5 seconds after connecting the copyboard's AC power plug to the wall power outlet or after turning off the power (standby mode) before pressing the ON/Standby button.
- Press the ON/Standby button to switch on the power. The LED of the display window will light.
- Turn on the copyboard's power before turning on the printer's power.



**Press the Feed/Stop button (for model M-12S, the Page change buttons) and display the sheet surface you want to print.**



**For models M-12S and M-12W**

A press of the Feed/Stop button scrolls the sheet surface one screen portion left and automatically stops it.

To stop the operation part way through, press the Feed/Stop button again.

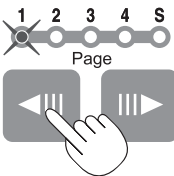

**For model M-125**

When the desired page is specified using the Page change buttons (the corresponding page indicator flashes), the sheet scrolls to the specified page and stops automatically (the page indicator stops flashing, remaining lit).

**Note**

- The one-screen that is visible is printable position.
- To fine-adjust the sheet surface position (M-12S and M-12W only), with the sheet stopped, move the sheet slowly by hand. The sheet can be moved either to the left or to the right.
- It is not possible to print the image projected on the S page (screen) (model M-125 only).
- Printing of the portion located around the sheet surface might not be possible. Please see "Effective reading size" on Page E-9.

Continued on next page

Step 2 (continued)

**Notice**

- If the display content of the page indicator does not agree with that of the actual page, move the copyboard to either Page 1 or the S page. (Model M-125)
- For model M-125, do not move the sheet surface by hand. Doing so could damage the copyboard.
- For Models M-12S and M-12W, the sheet surface can be moved, but the Erase Reminder function may not work properly.

**M-12S/M-12W**

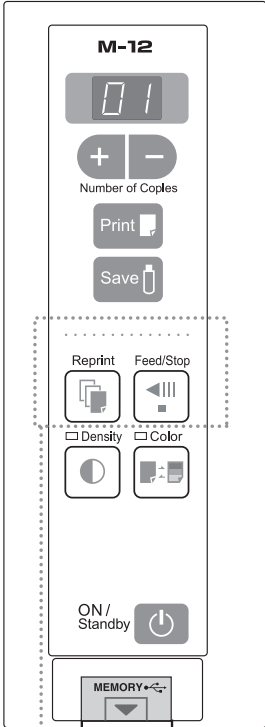

**M-125**

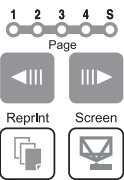

**3**

Press the **Color** button and select **Color** or **Black & White**.

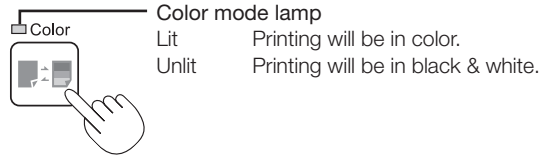

**4**

Press the **+** button or the **-** button and select the number of copies.



- When the power is switched on, one copy is selected.
- A maximum of 20 copies can be set and the number of copies is displayed in the display window.
- Each press of the + button increases the number of copies (by one) and each press of the - button decreases the number of copies. Press and hold the button to switch continuously.

**5**

Press the **Print** button to print.



- The reading operation is performed for a one-sheet portion (while the sheet is scrolled) and the printing operation is performed.

**Note**

- If the **Feed/Stop** button (for model M-125, the **ON/Standby** button) is pressed while the sheet surface is being read, printing is interrupted and only part of the image will be printed.  
To move the sheet surface, wait until scrolling stops, then press the **Feed/Stop** button (for model M-125, the **Page change** / buttons).
- When the fourth page has been printed, after the reading of the page is completed (i.e., printing is completed), there will be a return to Page 4.
- When a USB memory has been inserted, a press of the **Save** button during printing will start the USB memory storage operation after printing is completed. (See Page E-24.)
- The one-screen portion is reduced to A4 paper size and printed.  
For wide type copyboards (model M-12W), the image is compressed about 75% in the horizontal direction. To print with the same proportions as the image on the sheet surface, see "Printing in the same ratio as the sheet surface" (page E-23).
- A flashing "E 1" in the display window indicates a print error. See "Meaning of Error Messages" on Page E-33.

# Printing



When the copyboard is not going to be used, press the ON/Standby  button and switch off the power (standby mode).



- Switch off the printer power.

### Note

• **When the Erase Reminder function is set to "Enable"**

When the ON/Standby  button is pressed, the display window and all the indicators flash simultaneously, the sheet automatically moves to the surface that is not yet erased and the power turns off. (For Model M-125, the sheet moves to the start of the surface that is not yet erased and the power turns off.)

\* The Erase Reminder function may not work properly due to dirt on the sheet's adhesive sections or marker residue.

- If no button is operated for 30 minutes or greater, the unit is set to the sleep mode and the LEDs on the control panel turn off. If the power button is pressed, the LEDs on the display window turn on. If the print button  is pressed at this time, the printing operation starts.



## Selecting the printing density

Select this when the density of the print is light.

Press the Density  button and select darker or standard.

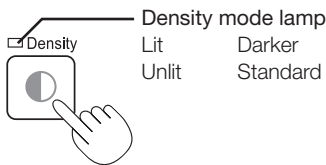

For More Info

Click Here --->



## Making additional copies

This will print the copy of the sheet that was scrolled previously one more time.

Press the Reprint  button.

This starts the printing of the image data that has accumulated in internal memory.

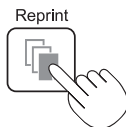



### Note

- The sheet is not scrolled when additional copies are made.
- The number of copies can be changed. To do so, make the change before pressing the Reprint  button.
- In repeat printing, the color/black & white and density settings will be the same as those of the prior printing.
- When printing or USB memory storage has not been performed since switching on the power, image data will not have accumulated in the internal memory and this operation will not be possible.
- If additional printing is set to "Disable" in the security function settings, display number "E8" is displayed. For details, see the separate "Software Operation Manual".

## Cancellation of the print operation in progress

### During the read operation (when the Print button was pressed)

When the Feed/Stop  button (for model M-125, the ON/Standby  button) is pressed, the reading of the sheet stops (for model M-125, the copyboard returns to the original page), and the partially read image data is printed. Wait until the sheet is expelled from the printer.

For models M-12S and M-12W



For model M-125



Continued on next page

M-12S/M-12W

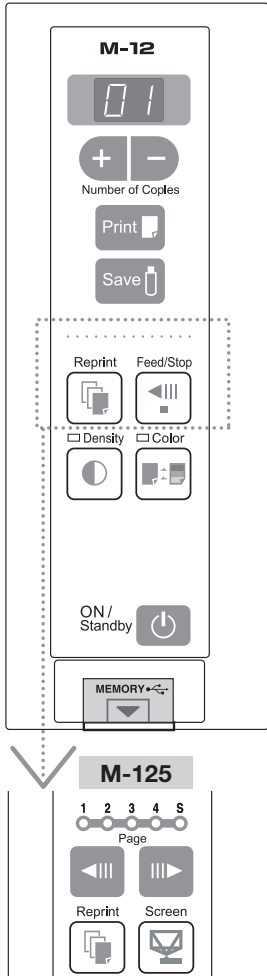

continued from previous page

**Stopping the printing after the Print button was pressed and the reading completed**

**Stopping the process when multiple copies are being made when making additional copies (When the Reprint button has been pressed)**

Press the copyboard's ON/Standby button. After several seconds, printing is interrupted and the sheet is expelled.

**Specifying the Page (model M-125)**

Press the Page change buttons to make the page indicator for the desired page flash. The sheet is scrolled to that page.

**Page indicators**

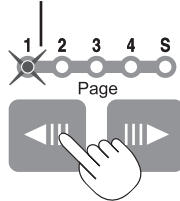

**Page change right button**

Each time the button is pressed, the page indicators flash in the order 1 → 2 → 3 → 4, the sheet scrolls to the specified page then stops, and the corresponding page indicator stops flashing, remaining lit.

**Page change left button**

Each time the button is pressed, the page indicators flash in the order S → 4 → 3 → 2 → 1, the sheet scrolls to the specified page then stops, and the corresponding page indicator stops flashing, remaining lit.

**Note**

- Scrolling to the screen (S page) is not possible with the right page change button.
- The S page cannot be specified by pressing the left page change button when at Page 1.
- Page 1 cannot be specified by pressing the right page change button when at the S page.
- Holes can be seen moving at the bottom of the sheet while the sheet is scrolling. These holes are normal (the copyboard is not damaged).
- The sheet may not look flat while it is moving. This is normal.
- The writing on the sheet may be blurred in parts when the sheet surface is rewound.

**Notice**

- If the display content of the page indicator does not agree with that of the actual page, move the copyboard to either Page 1 or the S page.

**Switching to the screen (model M-125)**

You can switch to the screen at the touch of a button. This screen is for use with regular or overhead projectors or other optical devices.

**Screen**



**With the sheet surface at some point between page 1 and page 4, press the Screen button.**

When the button is pressed, the "S" page indicator flashes green and the sheet scrolls to the screen.

When pressed again, the sheet scrolls back to the page at which it was previously set.

**Note**

- When the power is switched off (in standby), or the AC power plug has been disconnected, pressing the Screen button again will not result in a return to the original page.

**Notice**



- The S page is a screen for projecting the images of optical devices. Do not write on it, as ink cannot be erased from this screen. Also note that images projected on this screen cannot be printed or stored in a USB memory device.

# Printing

## Printing in the same ratio as the sheet surface (Model M-12W)

The M-12W has a wide screen, so when printing, the image is reduced in the horizontal direction and printed over the entire surface of the A4 sheet (so for example circles become ovals). If you wish to print with the same vertical-to-horizontal aspect ratio as the sheet surface (with the same image as on the sheet), change the printing ratio. Upon shipment from the factory (by default), the copyboard is set to compress the image in the horizontal direction.

Check that the power is turned on (that the display window is lit).

1. While pressing in the Density  button, press the ON/Standby  button to switch to the function settings mode.

"F1" appears on the display window.



2. Press the + or - button (the display switches each time one of the buttons is pressed) to display "F4", then press the Print  button to finalize.

When "F4" is displayed, the copyboard is in the printing ratio setting mode.



3. Press the Feed/Stop  button to select the equal ratio mode.

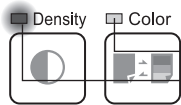

Lamps when the copyboard is set to condense the image in the horizontal direction:

- Color mode lamp: Off
- Density mode lamp: Lit

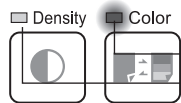

Lamps when the copyboard is set to print in equal ratio:

- Color mode lamp: Lit
- Density mode lamp: Off



Check that the lamps are lit or off as indicated at "Lamps when the copyboard is set to print in equal ratio" above, then press the Print  button to finalize. The dot next to the "F4" dot flashes for several seconds.

Dot flashes for several seconds

- To restore the copyboard to print with the image condensed in the horizontal direction, switch the mode so that the lamps are as indicated at "Lamps when the copyboard is set to condense the image in the horizontal direction", then press the print  button.

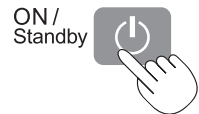

This completes the setting. Press the ON/Standby  button to return to the normal mode.

## Moving the sheet surface manually (Model M-12S/M-12W)

The sheet can be moved even when the power of the copyboard is switched off.

The sheet can be moved with your hand either in left or right. Please place your hand at the vertical center and move the sheet slowly. Quick movement can cause damage to the drive mechanism of the copyboard.

**Note**

- When the Erase Reminder function is set to "Enable", the function may not operate properly if the sheet surface is moved by hand.

**Notice**

- For model M-12S, do not move the sheet surface by hand. Doing so could damage the copyboard.

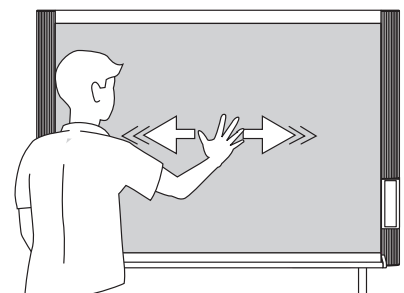

For More Info

Click Here ---->



# Using USB Memory

The content of what has been drawn on the sheet surface of the copyboard can be saved in USB memory. Later, the saved image can be read into a personal computer and made into a document of the proceedings of the meeting, or affixed to a document.

### • What is needed to use the USB memory function

USB memory: Commercially-available product

Personal computer: The connector is a USB port (type A), and the interface supports USB 1.1

### Note

- The copyboard supports the USB memory formats of FAT and FAT 32.
- The factory default for the resolution of images when storing them on USB memory devices is "Standard". There are two ways to switch this to a high resolution: by changing the copyboard's function Settings (see page E-29), or by setting "Resolution" in TOOLBOX to "High Resolution". (For instructions on operating TOOLBOX, see the separate "Software Operation Manual".)
- More time is required for storing images when the resolution is set to high.

### Notice

- For a description of the USB memory devices usable with this copyboard, please go to our website at: <http://www.plus-vision.com>

## USB Memory Storage Procedure

### Preparation:

Check that the copyboard's AC power plug is connected to a wall power outlet. See page E-15.

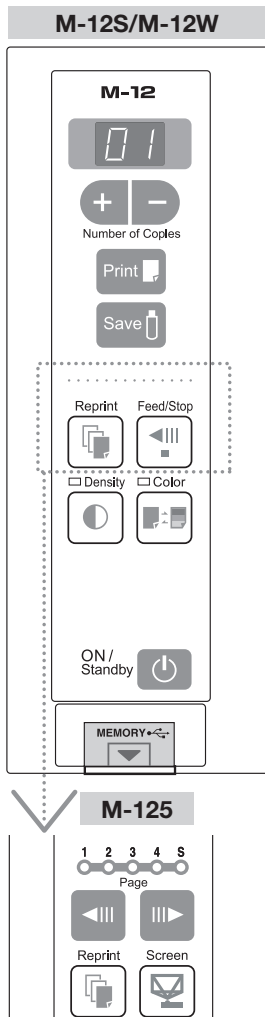

# 1

Press the ON/Standby button and switch on the power.



### Note

- When turning on the power, wait about 5 seconds after connecting the copyboard's AC power plug to the wall power outlet or after turning off the power (standby mode) before pressing the ON/Standby button.
- Press the ON/Standby button to switch on the power. The LED of the display window will light.

# 2

Insert the USB memory device into the Memory port (USB port) of the copyboard

### Notice

- Check the side (polarity) of the USB memory device before inserting it. Forcing it in the reverse orientation will damage the USB port or USB memory device.
- Be careful not to bump into the USB memory device with hand or body while it is mounted. Doing so could damage the USB memory device or USB port.

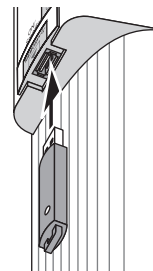

# 3

Press the Feed/Stop button (for model M-125, the Page change buttons) and display the sheet surface you want to store.

For models M-12S and M-12W

For model M-125



For More Info



Click Here --->

### Step 3 (continued)

The procedure for displaying the sheet surface you want to store is the same as for printing.  
See “Basic Printing Operation” on page E-19 and “Specifying the Page (model M-125)” on page E-22.

#### Notice

- The one screen portion that is viewable will be saved in USB memory.
- Saving of the portion located around the sheet surface might not be possible. Please see “Effective reading size” on Page E-9.

## 4

Press the Color button and select Color or Black & White.

Color mode lamp	
Lit	Printing will be in color.
Unlit	Printing will be in black & white.

## 5

Press the Save button to store

Flashing indicator “rotates” sequentially during USB memory storage operation.

Display window

- The reading operation is performed for a one-sheet portion (while the sheet is scrolled) and USB memory storage starts after the scrolling completes.



The (5 second) flashing “US” display indicates that the USB memory has not been inserted. Please insert the USB memory and then press the Save button.



A (5 second) flashing “FL” display indicates that there is insufficient free capacity to permit storage in USB memory. The flashing display will stop when the USB memory device is removed. Replace with a USB memory device having sufficient capacity. See “Meaning of Error Messages” on Page E-33 for other error displays.

#### Note

- Depending on the USB memory, it may take time for recognition or it may take time for saving.
- When the Feed/Stop (for model M-125, the Power button) is pressed during the reading operation, the reading operation will be discontinued and the partially read image data will be stored in the USB memory. To move the sheet surface, wait until scrolling stops, then press the Feed/Stop (for model M-125, the Page change / buttons).
- For model M-125, the image projected on the S page (screen) cannot be stored in the USB memory device.
- A press of the Print button during USB memory storage starts the printing after storage is completed.
- When the wide type (M-12W) copyboard has been adjusted to the paper size in the horizontal direction, the image will be compressed to about 75%.
- The date and time of the saved file will reflect the copyboard time setting. See “Setting the Time” on Page E-16.
- When a certain amount of free capacity is not available in the USB memory, “FL” will be displayed when the Save button is pressed. Also, when insufficient free capacity arises during saving, “FL” is displayed at that point. Delete data, set the sheet surface back to the original status, then press the Save button again.

Continued on next page

## Using USB Memory

### 6

#### Removing the USB memory

Check that the flashing rotation of the display window has changed to steady lighting and that the USB memory access indicator is not flashing, then pull the USB memory straight out. (Please see your USB memory manual for details.)

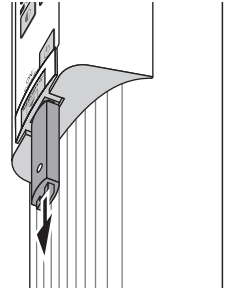

#### Note

- Do not unplug the USB memory device during the USB memory storage operation (i.e., during the rotating, flashing display in the display window), or while the access indicator of the USB memory device is flashing because data will be destroyed.

### 7

When the copyboard is not going to be used, press the ON/Standby  button and switch off the power (standby mode).



#### Note

- **When the Erase Reminder function is set to "Enable"**

When the ON/Standby  button is pressed, the display window and all the indicators flash simultaneously, the sheet automatically moves to the surface that is not yet erased and the power turns off. (For Model M-125, the sheet moves to the start of the surface that is not yet erased and the power turns off.)

- \* The Erase Reminder function may not work properly due to dirt on the sheet's adhesive sections or marker residue.
- "USB" letters appearing at one-second intervals in a moving display in the display window indicate that a USB memory device is mounted. Unplugging the USB memory device will switch off the power. (A function that serves as a reminder to unplug the USB memory device)
- If no button is operated for 30 minutes or greater, the unit is set to the sleep mode and the LEDs on the control panel turn off. If the power button is pressed, the LEDs on the display window turn on. If the save button is pressed at this time, storing of the data in the USB memory device starts.



Display window

For More Info

Click Here --->



## Using USB Memory

### Saving Image Files on a Computer/Deleting Image Files

Examples of operations follow for saving the image files in the USB memory device to the hard disk of the personal computer, and for deleting the folder when the USB memory capacity is full. (There are various methods that can be used for saving and deleting including the use of Explorer.) See the instruction manual of your personal computer or the software that you are using for information about using a personal computer.

The copyboard's folder on the USB memory device is named "CB\_image". The images are stored in this folder. By factory default set when the copyboard is purchased, the image files are named "PV-xxxxxxx.png" (in PNG format), where "xxxxxxx" is the date and number (for example (PV-08110801.png). The date is the date of shipment from the factory (in Japan Standard Time). If this differs from the current time in your location, change the copyboard's time. (See "Setting the Time" on page E-16.)

#### Note

The format in which the image files are stored can be set to "PNG", "JPEG" or "PDF". The factory default is "PNG". This format can be changed either in the copyboard's function settings (see page E-29) or in TOOLBOX at "Function Settings" -> "Image File Format". (For instructions on operating TOOLBOX, see the separate "Software Operation Manual".)

# 1

### Plug the USB memory device into a USB port of the personal computer

When connecting to the personal computer for the first time, the installation of a USB driver is required. Follow the instructions manual of the USB memory device that you are using.

- Usually, with Windows 2000/XP/Vista the standard driver is installed automatically and is identified as "Removable disk" in "My Computer."

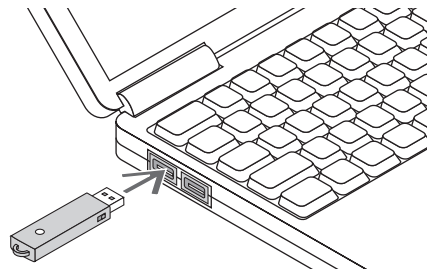

# 2

### Saving the image files of a USB memory device to a personal computer

#### 1. Open "My Computer" and from within, open the drive of the connected USB memory device.

The folder named "CB\_image" is the saved data of the copyboard.

#### 2. Store the "CB\_image" folder in "My Documents" or another location.

All of the data contained in "CB\_image" will be stored.

#### Notice

Depending on the computer's usage environment, these operations may not work properly. This could be the case for example:

- when several USB devices are connected simultaneously to the computer.
- when the USB device is connected to a USB hub or when it is connected using an extension cable.



For More Info

Click Here --->



## Using USB Memory

### Deleting USB memory image files with the computer

Before deleting important image files, be sure to save them on the computer (as a data backup).

**1. Open “My Computer” and then open the drive icon which shows USB memory.**

The folder named “CB\_image” contains the memory storage data of the copy-board.

**2. Place the “CB\_image” folder in the “Recycle Bin”, right click on the icon and select “Empty Recycle Bin” from the pull-down menu.**

All of the data contained in “CB\_image” will be deleted.

Even when the entire folder is deleted, a new CB\_image folder will be created automatically when USB memory is used again with the copyboard.



# 3

### Disconnect the USB memory

The disconnecting procedure depends on the computer's operating system. For details, refer to the computer's operating instructions or help files.

**1. Click the [Hardware Removal] icon that is displayed in the task tray.**

Click “Stop USB Mass storage Device - drive (E)”. (The E drive character will differ depending on the personal computer system.)

**2. Click [OK] when “The ‘USB Mass storage Device’ device can now be safely removed from the System” is displayed.**

(When using Windows XP/Vista, [OK] does not appear on the message screen. Simply disconnect.)

**3. This allows the USB memory device to be unplugged from the computer.**

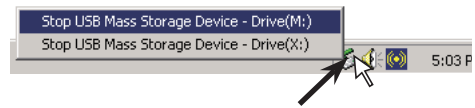

“Remove hardware” icon (example)



#### Note

- Do not disconnect the USB memory device while the USB memory device's access indicator is flashing. Doing so will damage the data.
- The USB drive may not be disconnected properly, for example if the computer is in the process of checking the status of peripherals.

For More Info

Click Here --->



# Making the Function Settings

The copyboard includes such advanced functions as the Erase Reminder function that can be set directly using the operation buttons on the copyboard. The advanced functions can also be set from the function settings in the "TOOLBOX" menu installed on a computer (See the separate "Software Operation Manual".)

## Basic Setting Operations

- Check that the power is turned on (that the display window is lit).
- When in the Function Settings mode, the copyboard returns to the normal mode if no button is operated for 10 seconds.

**1 Switching to the function settings mode**  
**Press and hold in the Density button, then press the ON/Standby button.**  
 "F1" appears on the display window.



**2 Selecting the function number**  
**Press the + or - button to display the desired function number (the number changes each time one of the buttons is pressed), then press the Print button to finalize.**



See the "Table of Function Numbers, Selected Modes and Lamp Statuses" on the following page.

**3 Selecting the function's setting**  
**Press the Feed/Stop button (or for Model M-125, use the page change buttons) to select the function's setting, then press the Print button to finalize.**

For models M-12S and M-12W For model M-125

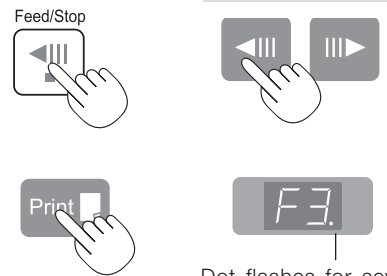

When finalized, the dot next to the function number ("F3." for example) flashes for several seconds.

- When the Feed/Stop button (or for Model M-125, one of the page change buttons) is pressed, the selected mode is indicated by whether the Density mode and Color mode lamps are on or off. For details, see the "Table of Function Numbers, Selected Modes and Lamp Statuses".

Dot flashes for several seconds

Ex.: Lamp statuses when selecting the Erase Reminder function's mode

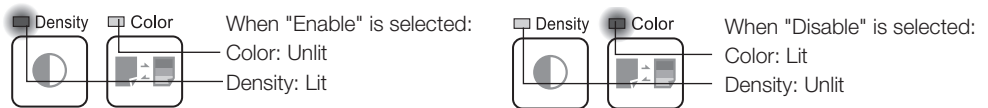

- Use the + and - buttons to select the date and time when setting the clock. (See page 16.)

**4 Quitting the function settings mode**  
**Press the ON/Standby button to return to the normal mode.**



The number of copies reappears on the display window.

For More Info

Click Here --->



## Making the Function Settings

### Table of Function Numbers, Selected Modes and Lamp Statuses

When at step 2 under "Basic Setting Operations" on the previous page, display the number of the function you want to set on the display window.

At step 3, check whether the lamps are lit or off as indicated for the desired mode.

Function number (Display window)	Function name	Description of function	Selected mode	Density mode lamp	Color mode lamp
F1	Time setting	Setting of the date and time for the time stamp	See page 16		
F2	Header/footer	Setting of the time stamp written when saving : By factory default Header/footer data output : Original editing *1	Disable	<input type="checkbox"/> Density Unlit	<input checked="" type="checkbox"/> Color Lit
			Enable *	<input checked="" type="checkbox"/> Density Lit	<input type="checkbox"/> Color Unlit
F3	Erase reminder	Sheet rear surface erase reminder function	Disable *	<input type="checkbox"/> Density Unlit	<input checked="" type="checkbox"/> Color Lit
			Enable	<input checked="" type="checkbox"/> Density Lit	<input type="checkbox"/> Color Unlit
F4	Printing ratio	Setting of image aspect ratio when printing (Model M-12W)	Compressed horizontally *	<input type="checkbox"/> Density Unlit	<input checked="" type="checkbox"/> Color Lit
			Equal ratio	<input checked="" type="checkbox"/> Density Lit	<input type="checkbox"/> Color Unlit
F5	Data rate	Setting of rate for images stored in the memory and images transferred to the computer (Model M-12W)	Compressed horizontally *	<input type="checkbox"/> Density Unlit	<input checked="" type="checkbox"/> Color Lit
			Equal ratio	<input checked="" type="checkbox"/> Density Lit	<input type="checkbox"/> Color Unlit
F6	Paper size	Setting of printing paper size	A4 *	<input type="checkbox"/> Density Unlit	<input checked="" type="checkbox"/> Color Lit
			Letter	<input checked="" type="checkbox"/> Density Lit	<input type="checkbox"/> Color Unlit
F7	Resolution	Setting of resolution for images stored in the memory and images transferred to the computer	Standard *	<input type="checkbox"/> Density Unlit	<input checked="" type="checkbox"/> Color Lit
			High	<input checked="" type="checkbox"/> Density Lit	<input type="checkbox"/> Color Unlit
F8	Image format	Setting of format of images stored on the USB memory device	JPEG	<input checked="" type="checkbox"/> Density Lit	<input type="checkbox"/> Color Unlit
			PNG *	<input type="checkbox"/> Density Unlit	<input checked="" type="checkbox"/> Color Lit
			PDF	<input checked="" type="checkbox"/> Density Lit	<input checked="" type="checkbox"/> Color Lit
F9	Test print	Print copyboard's pre-stored test pattern	See page 35		
FA	Reset OKI drum counter	Reset the Oki Data B2200n page printer's drum counter *2	-		
Fb	Restrict color mode	Setting for disabling printing/storing in the color mode	Enable *	<input type="checkbox"/> Density Unlit	<input checked="" type="checkbox"/> Color Lit
			Disable	<input checked="" type="checkbox"/> Density Lit	<input type="checkbox"/> Color Unlit
FC	Factory reset	Reset all the settings to their factory defaults.	-		

★ : Factory defaults.

\*1) For instructions on editing the header/footer, see the "Software Operation Manual".

\*2) Only on compatible printers.

For More Info

Click Here ---->

E-30



# Accompanying Software

See the Copyboard Software Operation Manual and the Help screens of the various software for information about the method of using the software contained on the accompanying CD-ROM.

## Software Contents and Overview

### • USB Driver

This driver allows the computer to recognize the Copyboard as an external device when there is a USB connection. Be sure to install this USB driver when connecting the USB port for PC connection with the computer.

### • TWAIN Driver

This driver is used to acquire the scanned data into a computer as an image.

\* This driver may not work on some applications.

\* This driver conforms to TWAIN standard (ver. 1.9).

### • "PLUS TOOLBOX" dedicated software

This is a utility for loading images from a computer, setting the copyboard's operating environment, making security settings, etc.

### • User's Manual

The User's Manual is stored on the CD-ROM in PDF format.

If Acrobat Reader is not installed on the PC, click "Acrobat Reader" on the menu and install it according to the instructions on the screen.

### • Acrobat Reader

This software is used to view PDF files.

### • Browsing the CD-ROM

Explorer running on the personal computer is used to display the contents of the CD-ROM.

### • Copyrights and usage conditions

This opens the copyrights, usage conditions, etc.

#### Note

- When installing on Windows 2000, please install the software with "Administrator" authority (i.e., a user having administrator authority).
- When installing on Windows XP/Vista, please install the software with "Computer Administrator" authority (account).

#### Notice

##### Help function

- The software's help file uses the online Microsoft HTML help format.

##### User Account Control in Windows Vista

- When the User Account Control setting is disabled, the software may not function properly.

For More Info

Click Here --->



## Accompanying Software

### Operating Environment

Supported OS:	Microsoft Windows 2000 Professional (Service Pack 4 or later)/ XP (HomeEdition / Professional Edition Service Pack 2 or later)/ Vista (32 bit version)
Supported PC:	IBM PC/AT or completely compatible machines that operate the aforementioned OS
CPU:	Pentium III 1.2GHz or later
Memory:	Windows 2000 (128 MB or bigger), Windows XP (256 MB or bigger)
Free hard disk space:	40 MB or greater (not including space for storing images)
Display resolution:	800 × 600 pixels or higher
Peripheral devices:	a CD-ROM /DVD-ROM drive, a standard USB port (USB 1.1 or 2.0)
Web browser:	Internet Explorer 6.0 or later

#### Notice

- All operations are not guaranteed under the aforementioned operating environment.
- Windows 95, 98SE/Me, NT, 2000 Server, Server 2003, and Vista (64 bit version) are not supported.

For More Info

Click Here --->



### Factory defaults

The "Settings" menu of the "PLUS TOOLBOX" dedicated software on the included CD-ROM can be used to change the copyboard's settings.

For setting instructions, see the separate "Software Operating Instructions".

Below are the setting items and factory defaults.

Setting item	Description	Factory default
Date/time setting	Set of the date and time for the time stamp	Japan Standard Time
File Format	Sets the format of the images stored on the USB memory device. JPEG / PNG / PDF	PNG
Paper Size	A4/Letter	A4
Aspect Ratio	Sets the aspect ratio for printed images. Original Image / Match Paper Size	Match Paper Size
Erase Reminder	Sheet rear surface erase reminder function: Disable/Enable	Disable
Restrict color mode	Setting for disabling printing/storing in the color mode	Disable
Resolution	Selection of resolution for images stored in the memory and images transferred to the computer : Standard Standard : 1/2 the vertical/horizontal size of the scanned image High : 1/1 the vertical/horizontal size of the scanned image	Standard
Header/footer (date/time stamp)	Upon shipment from factory : Writing of date/time when printing/storing : Enabled/Disabled Original editing : Header/footer data output *	Enabled

- \* The date/time stamp can be displayed at the user's discretion as part of the header/footer data.  
Upon shipment from the factory, only the time stamp is displayed.

# Meaning of Error Messages

If any of the following flashing indications appear in the display window of the control panel, please check the matters described below. Error messages will flash for 5 seconds; however, error displays of “E4”, “E5”, “E6” and “E8” will be lit steadily after the flashing stops.



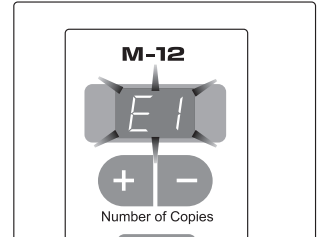

For More Info

Click Here --->



Error Display Number	Problem and Solution	
<b>E1</b> <b>Printer not connected</b> <b>No printing paper</b> <b>Printer problem</b>	<ul style="list-style-type: none"> <li>Is the printer cable connected?</li> <li>Is power being supplied to the printer?</li> <li>When the printer uses an AC power adapter, is the cable disconnected somewhere?</li> <li>Has paper been set in the printer?</li> <li>Is the printer error indicator flashing (or lit)?</li> </ul>	<ul style="list-style-type: none"> <li>Connect the printer properly and switch on the printer power.</li> <li>Turn the power of the printer off and then on again, and load the printer with A4 paper.</li> <li>Read the printer instruction manual.</li> </ul>
<b>E2</b> <b>USB Memory not recognized</b>	<ul style="list-style-type: none"> <li>Is the USB memory unformatted.</li> <li>Is a USB memory that is not supported by the copyboard being used?</li> <li>Is the USB memory device plugged in fully?</li> <li>Is the USB memory damaged?</li> </ul>	<ul style="list-style-type: none"> <li>This unit supports the FAT and FAT 32 formats. Perform the formatting with the personal computer.</li> <li>Please see our home page for information about USB memories that can be used with the copyboard. <b>( <a href="http://www.plus-vision.com">http://www.plus-vision.com</a> )</b></li> <li>Please check the operation with a personal computer.</li> </ul>
<b>E3</b> <b>USB Memory storage problem</b>	<ul style="list-style-type: none"> <li>An error occurred during USB memory storage.</li> </ul>	<ul style="list-style-type: none"> <li>Please perform USB memory storage again.</li> <li>Do not insert or remove the USB memory during processing.</li> </ul>
<b>E4</b> <b>Reading problem</b>	<ul style="list-style-type: none"> <li>There is a lighting fault of the reading light source, or a read signal error.</li> </ul>	<ul style="list-style-type: none"> <li>Unplug the power plug from the power outlet and then plug it in again.</li> </ul>
<b>E5</b> <b>System error</b>	<ul style="list-style-type: none"> <li>There is a memory or internal fault.</li> </ul>	<ul style="list-style-type: none"> <li>Unplug the power plug from the power outlet and then plug it in again.</li> </ul>
<b>E6</b> <b>Page detection error (model M-125 only)</b>	<ul style="list-style-type: none"> <li>The pages are not being properly detected.</li> </ul>	<ul style="list-style-type: none"> <li>Unplug the power plug from the power outlet and then plug it in again.</li> </ul>
<b>E8</b> <b>Security protection</b>	<ul style="list-style-type: none"> <li>You have attempted to use a function disabled by the security settings.</li> </ul>	<ul style="list-style-type: none"> <li>The settings can be changed using the exclusive software. For details, contact your nearby PLUS Vision sales office, dealer or store.</li> </ul>
<b>E9</b> <b>Restrict color mode</b>	<ul style="list-style-type: none"> <li>Setting for disabling printing/storing in the color mode.</li> </ul>	<ul style="list-style-type: none"> <li>Can be changed in the copyboard's "Function Settings". For setting instructions, see page E-29.</li> </ul>
<b>U5</b> <b>USB memory not connected</b>	<ul style="list-style-type: none"> <li>USB memory device is not plugged into the main unit.</li> </ul>	<ul style="list-style-type: none"> <li>Plug the USB memory device into the USB port.</li> </ul>
<b>When the “USB” letter display is flowing...Warning that disconnection of USB memory has been forgotten</b>  	<ul style="list-style-type: none"> <li>Did you press the ON/Standby button while the USB memory device was plugged into the main unit?</li> </ul>	<ul style="list-style-type: none"> <li>A USB memory device is plugged into the main unit. When the USB memory device is disconnected, the power will be switched off and the unit will enter the standby mode.</li> </ul>

## Meaning of Error Messages / Troubleshooting

	<b>USB Memory is full</b>	<ul style="list-style-type: none"> <li>• There is no available space.</li> </ul>	<ul style="list-style-type: none"> <li>• Please delete unnecessary data using a personal computer (See Page E-27).</li> </ul>
	<b>An unsupported printer is connected</b>	<ul style="list-style-type: none"> <li>• A printer that is not supported by the copyboard has been connected.</li> </ul>	<ul style="list-style-type: none"> <li>• Press the ON/Standby  button and switch off the power. When a record is required, switch on the power and save to USB memory.</li> </ul>
	Time setting error	<ul style="list-style-type: none"> <li>• An error has arisen when setting the time.</li> </ul>	<ul style="list-style-type: none"> <li>• When the ON/Standby  button is pressed, the display switches to "c1". Start the setting over from the year.</li> </ul>

If the problem persists, please contact your nearby PLUS Vision sales office, dealer, or store.

## Troubleshooting

Please check the following matters before making a request for servicing.

	Condition	Please Check
<b>Copyboard Related</b>	Pressing the ON/Standby  button does not switch on the power.	<ul style="list-style-type: none"> <li>• Check whether the cable of the AC power adapter is disconnected from the DC connector of the Copyboard or the wall outlet. (Unplug the AC power cable from the outlet, wait several seconds and then plug it back into the outlet again.)</li> </ul>
	Writing on the sheet is not erased with the eraser.	<ul style="list-style-type: none"> <li>• Was a marker other than a dedicated marker used? (Moisten a cloth with water or neutral detergent, wring well, and wipe carefully.)</li> </ul>
	Portions of writing or lines are not printed or stored in memory.	<ul style="list-style-type: none"> <li>• Portions of blurred characters or thin lines may not be printed or stored in USB memory.</li> <li>• Change Density setting to "Dark".</li> </ul>
	Scanned copy (image) is dirty, Erase Reminder function is activated even when sheet is erased with the eraser	<ul style="list-style-type: none"> <li>• Is there marker residue or substantial quantities of refuse on the sheet? (If the sheet is dirty, moisten a soft cloth with water, wring well, then wipe the sheet in a stroking manner.)</li> </ul>
	The ruled line of the sheet appears on the print or in the file of the USB memory, or the black ink mixes into other color in the case of Color Mode.	<ul style="list-style-type: none"> <li>• Check the density indicator, and select standard density if the setting is darker.</li> </ul>
	When the copyboard and PC are connected, the supplied utility program does not operate after installation of the USB driver	<ul style="list-style-type: none"> <li>• Has the USB driver in the CD-ROM been properly registered in the device manager? (An exclamation mark (!) will be affixed if it has not been registered.) (If not registered, delete the USB driver and reinstall it.)</li> </ul>
	When the copyboard and PC are connected, the PC does not recognize the copyboard	<ul style="list-style-type: none"> <li>• Check whether the copyboard is in an operable condition, and whether the USB cable is connected properly.</li> <li>• Is the copyboard connected to the PC via a USB hub? (Connect the copyboard directly to the USB port of the PC.)</li> </ul>

\* If the problem persists, please contact your nearby PLUS Vision sales office, dealer, or store.



For More Info

Click Here --->



	<b>Condition</b>	<b>Please Check</b>
<b>Printer Related</b>	A press of the Print  button does not result in printing.	<ul style="list-style-type: none"> <li>• Check that the power cable of the printer and the printer cable are securely connected.</li> <li>• Check that the printer power indicator is lit.</li> <li>• Check that the error indicators of the copyboard and the printer are not lit.</li> <li>• If the error indicator of the copyboard is flashing, please see Page E-34. (Please see the printer instruction manual for information about printer errors.)</li> </ul>
	The paper feed is abnormal.	<ul style="list-style-type: none"> <li>• Possible causes include damp paper, overly thin or thick paper, only one sheet of paper is set, and a curved setting of the paper. (Please see the instruction manual for your printer.)</li> </ul>
	An altered color is printed, not the specified color.	<ul style="list-style-type: none"> <li>• Please replace the print cartridges with new ones.</li> </ul>
	There is no printing.	<ul style="list-style-type: none"> <li>• Check that the print cartridge is properly set.</li> <li>• Check that the print cartridge is not plugged.</li> </ul>
	<ul style="list-style-type: none"> <li>◦ Print is very pale, there are white lines on it, or page is dirty.</li> <li>◦ Printed colors are very different from those of the markers that were used.</li> </ul>	<ul style="list-style-type: none"> <li>Is the print cartridge's nozzle partially choked?</li> <li>◆ Make a test print and check the conditions of the nozzle.</li> </ul>

**Test Printing** (This is done with the copyboard's function settings. See page E-29.)

- 1) With the copyboard's power turned on (the display window lit), press and hold in the Density  button, then press the ON/Standby  button. "F1" appears on the display window (function settings mode).
- 2) Use the + or - button to display "F9" (test print).
- 3) Press the Print  button to finalize.

**\* Test printing starts.**

**Check the print**

- Is the each color line printed uniformly?
- Are there missing dots, pale lines, lines with thinner ink than others, etc.?

**Remedy**

- ◆ If the nozzle is partially choked, clean it.
- ◆ If the quality of the print does not improve even though the nozzle has been cleaned, wipe off the ink on the surface of the nozzle.

For details, see the "User's Guide" included with the printer.

\* Please see your printer manual for information about printing problems, printer maintenance, and details related to printing.



# Specifications

BOARD TYPE (Model name)		Standard (M-12S)	Wide (M-12W)	5-surface (M-12S)
Form	Installation method	Self-standing (T-shaped legs), or wall mounting		
	External dimensions (T-shaped legs*1)	W1470 × D700 × H1970*2 mm	W1970 × D700 × H1970*2 mm	W1470 × D700 × H1970*2 mm
	Main unit weight	31 kg*3	35 kg*3	35 kg*3
	T-shaped legs weight	9.6 kg		
BOARD	Panel Size	H920 × W1300 mm	H920 × W1800 mm	H920 × W1300 mm
	Effective reading size	H900 × W1280 mm	H900 × W1780 mm	H920 × W1280 mm
	Number of Pages	2		5 (4 sheet surfaces + 1 screen surface)
	Paging	Endless in one direction (Horizontal scrolling)		Wind-up type
	Drive method	Sheet movement		
	Reading method	CCD sensor reduction optical system		
	Reading illumination light source	RGB LED		
	Reading resolution	Main scanning direction (vertical sheet surface) 2.4 dots/mm (60 dpi or equivalent) Sub scanning direction (horizontal sheet surface) 2.4 dots/mm (60 dpi or equivalent)		
Memory	Reading time	Black & white: approx. 15 s Color: approx. 23 s	Black & white: approx. 20 s Color: approx. 31 s	Black & white: Approx. 15 s Color: Approx. 23 s
	Type	USB Flash memory		
	Compatible FAT types	FAT 12, 16, 32		
	File format	PNG, JPEG and PDF format		
Control panel	Interface	USB1.1 or USB2.0 full-speed mode*4		
	Control buttons	ON/Standby, +, -, Print, Save, Reprint, Color, Density, Feed/Stop		ON/Standby, +, -, Print, Save, Reprint, Color, Density, ◀, ▶ (Page Change), Screen
	LED Indicators	Density, Color		Density, Color, Page LEDs
Added functions	Display	7-Segment (Page, Error#),		
	Clock	Used for the timestamp and for file dating properties (Includes backup battery for when there is a loss of power)		
Power supply	PC connection	Transfer of sheet surface image data via USB (TWAIN supported)		
	AC power adapter	Input : AC100-240V/50-60 Hz, Max 1.5 A Output : DC 24 V, 2.71 A		
Operating conditions	Temperature:	10-35°C		
	Humidity:	30-85% (No condensation)		
Recording Section	Printer interface	USB1.1 or USB2.0 full-speed mode*4 compliant printers are supported		
Miscellaneous	Ruled lines	50 mm cross-ruled squares		
	Miscellaneous	Dedicated markers (black, red, blue, and green)		

Remarks

- \*1: The height is adjustable at 1770, 1870 and 1970 mm.
- \*2: The value indicated for "H" (height) is the maximum height.
- \*3: Not including the weight of the printer.
- \*4: Not correspond High-speed mode.

For More Info

Click Here --->



- Please note that for quality improvement purposes, specifications and design are subject to change without prior notice.
- This machine contains eParts of the eSOL, Co., Ltd.
- Depending on the product, the printer and T-shaped legs (stand) will be available separately.

## Connections and Wiring Diagram

- The connections and wiring diagram below is included here for checking the connections.

\* For connection of the copyboard and computer, see the separate "Software Operation Manual".

### [Copyboard and Printer Connections Diagram]

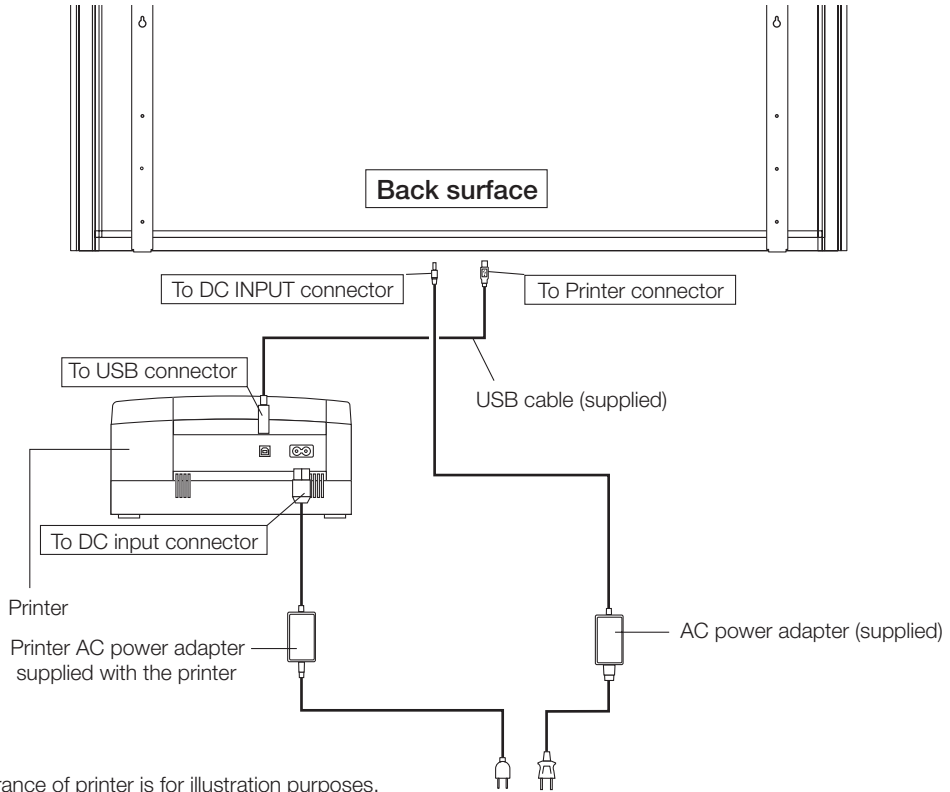

\* Appearance of printer is for illustration purposes.

#### Note

The AC power adapters of accessories and printers that have been verified to be operation many differ from the ones shown on the connections diagram (they may be of the built-in or mounted-on type).

For More Info

Click Here ---->

